



**Microlitre  
Centrifuges,  
non-refrigerated  
and refrigerated**

DJB Labcare - The UK's Leading Centrifuge Specialist  
info@djblabcare.co.uk www.djblabcare.co.uk  
02003 612598

**MIKRO 22 and MIKRO 22 R are small, compact benchtop centrifuges for processing microlitre tubes of 0.2 ml to 2.0 ml, and hematocrit capillaries.**

**Yet, they have a lot more to offer!**

The refrigerated MIKRO 22 R also accommodates cyto suspensions and tubes up to a capacity of 50 ml.

The MIKRO 22 type centrifuges are used for routine examinations of

patients' sera as well as in genetics research, virology, cytology, and bacteriology.

Capacity, performance and cooling of the MIKRO 22 R are specifically designed to meet the demands of PCR examinations.

Super rapid run-up and run-down times shorten the centrifuging operations significantly without stirring the sediment during deceleration.

## MIKRO 22 centrifuges in brief

### Performance

RCF of 31,514 in an angle rotor, RCF of 18,516 in a swing-out rotor, max. speed of 18,000 min<sup>-1</sup>.

### Rotors for various applications

Seven microlitre rotors (2 of them aerosol-tight), 2 angle rotors, 2 swing-out rotors, 1 hematocrit and 1 cyto rotor are available.

### Technology

**Brushless maintenance-free drive** provides for smooth running and extraordinary speed stability.

**Special lid locking device** for effortless closing and opening of the lid with one hand.

**Viewing port in the lid** for additional speed control during centrifugation.

**Three complete running programmes can be stored and recalled.**

### Cooling

**with the MIKRO 22 R** steplessly controllable within a range of -20 °C to +40 °C.

### Safety:

**Metal housing**

**Centrifuging chamber of stainless steel**

**Automatic rotor recognition**

**Imbalance switch-off**

**Aerosol-tight rotors**

**Lid locking and holding**



Hettich manufactures high quality centrifuges.

All stages from design to end product are continually subjected to strictest controls.

Evidence of conformity with national and international regulations such as IEC 1010-2.2 and EC standards is provided by corresponding certificates.

Of course, Hettich centrifuges are CE marked.

The ISO 9001 certificate accredited to the entire company proves the extreme care and responsibility Hettich puts into the manufacture of centrifuges and their accessories.

Therefore, Hettich centrifuges are known for safety and reliability all over the world.

DJB Labcare - The UK's Leading Centrifuge Specialist  
info@djblabcare.co.uk www.djblabcare.co.uk  
01908 612598



**MIKRO 22 R**

refrigerated benchtop centrifuge  
dimensions (H x W x D):  
278 x 333 x 620 mm

Cat.-No. **1110**



**MIKRO 22**

benchtop centrifuge  
dimensions (H x W x D):  
278 x 333 x 390 mm

Cat.-No. **1105**

The fully developed up-to-date N control panel meets the requirements of the users and is extremely easy to operate.

Entry of the parameters is fast, precise and convenient with selector keys on the water-protected foil keypad.

The large display is well readable. During centrifugation the actual values of the parameters are indicated.

The parameters remain in the memory even after the centrifuge has been switched off.

**Speed RPM:** Input in increments of 10.

**Relative centrifugal force RCF:** Input in increments of 10.

**Change-over RPM/RCF:** By entering the rotor radius r/mm the centrifuge calculates and indicates speed or RCF.

**Running time t:** Input in minutes and seconds, max. 99 minutes.

**Run-up/run-down times:** Input of acceleration and braking ramps in levels 1 - 9 or unbraked run-down.

**Temperature T:** With refrigerated models input in increments of 1°C within a range of -20°C to +40°C.

**Memory:** 3 complete running programmes can be stored and recalled.

**Impulse key:** For short centrifuging operations. The rotor spins at the preselected speed or RCF as long as the key remains pressed.



DJB Labcare - The UK's Leading Centrifuge Specialist  
info@djblabcare.co.uk www.djblabcare.co.uk  
01908 612598

# Accessories



∠45°

Angle rotor, 12-place,  
n = 18,000 min<sup>-1</sup>,  
RCF 23,907

Cat.-No. **1157**



∠45°

Angle rotor, 24-place,  
n = 18,000 min<sup>-1</sup>, RCF 31,514

Cat.-No. **1195**

aerosol-tight <sup>2)</sup>



∠45°

Angle rotor, 30-place,  
n = 14,000 min<sup>-1</sup>, RCF 21,255

Cat.-No. **1189**









aerosol-tight <sup>2)</sup>

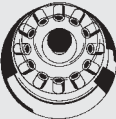



















∠45°









Angle rotor, 48-place, 2-row,  
n = 14,000 min<sup>-1</sup>, RCF upper row  
21,255, lower row 18,846

Cat.-No. **1158**

capacity in ml	0.4	0.5	0.8	1.5	2.0
dimensions Ø x L mm	6 x 45	8 x 30	8 x 45	11 x 38	11 x 38
Cat.-No.	-	-	-	<b>2078</b>	<b>0536</b>
 Cat.-No. <b>1157</b>					
				when centrifuging at high speeds we recommend to use adapter No. 2031	
Cat.-No.	<b>2024</b>	<b>2023</b>	<b>2023</b>	-	-
tubes per rotor	12				
RCF	23,907				
radius in mm	66				
run-up in sec	5				
run-down in sec	<input type="checkbox"/> 7 <input type="checkbox"/> 210				
temperature °C <sup>1)</sup>	- 5				

capacity in ml	0.4	0.5	0.8	1.5	2.0
dimensions Ø x L mm	6 x 45	8 x 30	8 x 45	11 x 38	11 x 38
Cat.-No.	-	-	-	<b>2078</b>	<b>0536</b>
 Cat.-No. <b>1195</b>					
				when centrifuging at high speeds we recommend to use adapter No. 2031	
Cat.-No.	<b>2024</b>	<b>2023</b>	<b>2023</b>	-	-
tubes per rotor	24				
RCF	31,514				
radius in mm	87				
run-up in sec	24				
run-down in sec	<input type="checkbox"/> 28 <input type="checkbox"/> 420				
temperature °C <sup>1)</sup>	+ 2				

capacity in ml	0.4	0.5	0.8	1.5	2.0
dimensions Ø x L mm	6 x 45	8 x 30	8 x 45	11 x 38	11 x 38
Cat.-No.	-	-	-	<b>2078</b>	<b>0536</b>
 Cat.-No. <b>1189</b>					
				when centrifuging at high speeds we recommend to use adapter No. 2031	
Cat.-No.	<b>2024</b>	<b>2023</b>	<b>2023</b>	-	-
tubes per rotor	30				
RCF	21,255				
radius in mm	97				
run-up in sec	20				
run-down in sec	<input type="checkbox"/> 24 <input type="checkbox"/> 420				
temperature °C <sup>1)</sup>	- 4				

capacity in ml	0.4	0.5	0.8	1.5	2.0
dimensions Ø x L mm	6 x 45	8 x 30	8 x 45	11 x 38	11 x 38
Cat.-No.	-	-	-	<b>2078</b>	<b>0536</b>
 Cat.-No. <b>1158</b>					
				when centrifuging at high speeds we recommend to use adapter No. 2031	
Cat.-No.	<b>2024</b>	<b>2023</b>	<b>2023</b>	-	-
tubes per rotor	48				
RCF	lower row	18,846			
	upper row	21,255			
radius in mm	lower row	86			
	upper row	97			
run-up in sec	20				
run-down in sec	<input type="checkbox"/> 20 <input type="checkbox"/> 410				
temperature °C <sup>1)</sup>	- 6				

braked run-down at level 9

unbraked run-down

<sup>1)</sup> Lowest attainable temperature with MIKRO 22 R centrifuges at max. speed.

<sup>2)</sup> In compliance with DIN EN 61010, part 2-020

Centrifugation in the 24-place swing-out rotor makes the pellet collect exactly in the tip of the reaction tubes. This facilitates analysis and further processing.

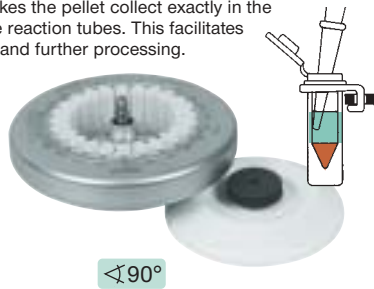

∠90°

**Swing-out rotor, 24-place,**  
n = 13,000 min<sup>-1</sup>, RCF 18,516

Cat.-No. **1154**



**Drum rotor, 6 compartments,**  
n = 13,000 min<sup>-1</sup>, RCF 14,150









Cat.-No. **1161**

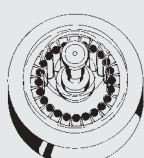











∠45°

**Angle rotor, 6-place,**  
n = 14,000 min<sup>-1</sup>, RCF 18,845

Cat.-No. **1160** without lid  
A lid, Cat.-No. 1162, is separately available.

capacity in ml	0.4	0.5	0.8	1.5	2.0
dimensions Ø x L mm	6 x 45	8 x 30	8 x 45	11 x 38	11 x 38
<b>Cat.-No.</b>	-	-	-	<b>2078</b>	<b>0536</b>
 <b>Cat.-No. 1154</b>					
					
<b>Cat.-No.</b>	<b>2024</b>	<b>2023</b>	<b>2023</b>	-	-
tubes per rotor	24				
RCF	18,516				
radius in mm	98				
run-up in sec	25				
run-down in sec	☐ 30 ☐ 420				
temperature °C <sup>1)</sup>	+ 11				

capacity in ml	0.4	0.5	0.8	1.5	2.0
dimensions Ø x L mm	6 x 45	8 x 30	8 x 45	11 x 38	11 x 38
<b>Cat.-No.</b>	-	-	-	<b>2078</b>	<b>0536</b>
 <b>Cat.-No. 1161</b>					
					
<b>Cat.-No.</b>	<b>1378</b>	<b>1379</b>	<b>1379</b>	<b>1377</b>	<b>1377</b>
tubes per rotor	192	126	126	60	60
RCF	14,150				
radius in mm	75				
run-up in sec	15				
run-down in sec	☐ 16 ☐ 370				
temperature °C <sup>1)</sup>	- 4				

1) Lowest attainable temperature with MIKRO 22 R centrifuges at max. speed.

This extensive range of rotors turns the MIKRO 22/22 R centrifuges into true microlitre specialists.

Customers' demands on hygiene and safety as well as convenient and easy handling have all been considered.

The rotors feature a detection system preventing them from being stressed beyond their design limit.

☐ braked  
run-down  
at level 9

☐ unbraked  
run-down

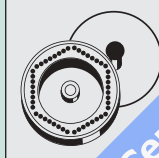
capacity in ml	0.2
PCR strips	8 - tube
<b>Cat.-No.</b>	-
 <b>Cat.-No. 1160</b>	
<b>Cat.-No.</b>	-
strips per rotor	6
RCF	18,845
radius in mm	86
run-up in sec	13
run-down in sec	☐ 12 ☐ 320
temperature °C <sup>1)</sup>	+ 8

# Accessories for MIKRO 22 R

Except for the hematocrit rotor No.1023 these rotors can only be run in the refrigerated MIKRO 22 R.

Also accepting rotors for tubes up to 50 ml and cytological slide preparations the refrigerated MIKRO 22R offers an extended range of applications.

## Speed is the thing!

With these robust angle rotors even large volumes can be centrifuged at high speeds. Both rotors are made of steel and finished in a scratch and impact resistant coating.



∠35°

Angle rotor, 6-place,  
n = 6,000 min<sup>-1</sup>, RCF 3,904

















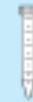

Cat.-No. **1016**







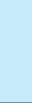

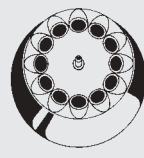

∠35°

Angle rotor, 12-place,  
n = 6,000 min<sup>-1</sup>, RCF 4,105

Cat.-No. **1015**

capacity in ml	7	15	25	30	50	50	15	50	9 - 10
dimensions Ø x L mm	12 x 100	17 x 100	24 x 100	26 x 95	29 x 107	34 x 100	17 x 120	29 x 115	16 x 92
Cat.-No.	<b>0578</b>	<b>0507</b>	<b>0519</b>	<b>0545</b>	<b>0546</b>	<b>0521</b>	<b>0509</b>	<b>0513</b>	blood collection tube
 Cat.-No. <b>1016</b>									
									
Cat.-No.	<b>1632</b>	<b>1635</b>	<b>1633</b>	<b>1633</b>	<b>1634</b>	-	<b>1631</b>	<b>1641</b>	<b>1635</b>
tubes per rotor	18	6	6	6	6	6	6	3	6
RCF	3,824	3,703	3,622	3,622	3,783	3,904	3,743	3,824	3,703
radius in mm	95	92	90	90	94	97	93	95	92
run-up in sec	19								
run-down in sec	<input checked="" type="checkbox"/> 20 <input type="checkbox"/> 350								
temperature °C <sup>1)</sup>	- 14								

capacity in ml	5	15	15	4 - 7
dimensions Ø x L mm	12 x 75	17 x 100	17 x 120	13 x 100
Cat.-No.	-	<b>0507</b>	<b>0509</b>	blood collection tube
 Cat.-No. <b>1015</b>		 <sup>2)</sup>		
				
Cat.-No	<b>1056</b>	-	-	-
tubes per rotor	12	12	6	12
RCF	3,421	4,105	4,105	4,105
radius in mm	85	102	102	102
run-up in sec	19			
run-down in sec	<input checked="" type="checkbox"/> 20 <input type="checkbox"/> 200			
temperature °C <sup>1)</sup>	- 14			

1) Lowest attainable temperature with MIKRO 22 R centrifuges at max. speed.

The MIKRO 22 further allows hematocrit determination and the preparation of samples for bilirubin determination.

As a special feature the hematocrit rotor is segmented into 24 chambers, each chamber containing one capillary only. In case a capillary breaks or leaks, fragments and leaked blood stay in the chamber and will not affect other capillaries.

The lid of the rotor is evaluation disc and cover in one. Its advantage: The hematocrit value can be determined fast and conveniently right after centrifugation.









in MIKRO 22  
and  
MIKRO 22 R

Hematocrit rotor, 24-place,  
with lid as evaluation disc,  
n = 15,000 min<sup>-1</sup>, RCF 21,382.

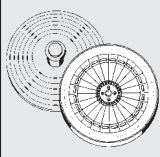
Cat.-No. **1023**

braked  
run-down  
at level 9

unbraked  
run-down

	capillaries heparinized	capillaries heparinized mylar-coated	capillaries heparinized self-sealing
Cat.-No.	<b>2074</b>	<b>1072</b>	<b>1071</b>
 Cat.-No. <b>1023</b>			
			
Cat.-No.	<b>2074</b>	<b>2074</b>	-
capillaries per rotor	24		
RCF	21,382		
radius in mm	85		
run-up in sec	9		
run-down in sec	<input checked="" type="checkbox"/> 10 <input type="checkbox"/> 200		
temperature °C <sup>1)</sup>	- 7		

DJB Labcare - The UK's Leading Centrifuge Specialist  
 info@djblabcare.co.uk www.djblabcare.co.uk 01908 512598

### Swing-out centrifugation on very little space!

The MIKRO 22 R accommodates most various blood collection tubes. This makes clinical chemistry one of its main fields of application.

Rotor No. 1020 is also ideal for the centrifugation of tubes with a gel barrier.



<50°

**Swing-out rotor, 6-place,  
n = 5,000 min<sup>-1</sup>, RCF 2,879**

Cat.-No. **1013** without suspensions



<90°

**Swing-out rotor, 8-place,  
n = 5,000 min<sup>-1</sup>, RCF 2,879**

Cat.-No. **1020** without suspensions

capacity in ml	5	10	15
dimensions Ø x L mm	12 x 75	17 x 70	17 x 100
<b>Cat.-No.</b>	-	<b>2079</b>	<b>0507</b>
 Cat.-No. <b>1013</b>			
	+1 x 1056 	+2 x 0716 	
<b>Cat.-No.</b>	<b>1123</b>	<b>1123</b>	<b>1123</b>
tubes per rotor	6	6	6
RCF	2,264	2,739	2,879
radius in mm	81	98	103
run-up in sec	9		
run-down in sec	9  110		
temperature °C <sup>1)</sup>	- 14		

capacity in ml	5	6	10	1.6 - 5	2.6 - 2.9	2.7 - 3	4 - 5.5	4 - 7
dimensions Ø x L mm	12 x 75	12 x 82	17 x 70	13 x 75	13 x 65	11 x 66	15 x 75	16 x 75
<b>Cat.-No.</b>	-	<b>0501</b>	<b>2079</b>	blood collection tubes				
 Cat.-No. <b>1020</b>								
<b>Cat.-No.</b>	<b>1131</b>	<b>1131</b>	<b>1132</b>	<b>1131</b>	<b>1131</b>	<b>1131</b>	<b>1132</b>	<b>1132</b>
tubes per rotor	8							
RCF	2,879							
radius in mm	103							
run-up in sec	9							
run-down in sec	9  110							
temperature °C <sup>1)</sup>	- 14							

1) Lowest attainable temperature with MIKRO 22 R centrifuges at max. speed.



**Cyto rotor, 4-place,  
n = 5,000 min<sup>-1</sup>, RCF 2,879**

Cat.-No. **1048** without suspensions

More information is available  
in a detailed brochure on the  
Hettich cyto system.

**Please ask for it!**

braked  
run-down  
at level 9

unbraked  
run-down

<sup>2)</sup> For glass tubes the max. RCF is 4,000. Please take care not to exceed the tubes' max. permissible RCF. For plastic tubes the max. RCF is 4,000.

DJB Labcare - The UK's Leading Centrifuge Specialist  
 info@djblabcare.co.uk www.djblabcare.co.uk  
 01908 612598

# Technical Details



**MIKRO 22**  
Benchtop centrifuge, without rotor  
Cat.-No. 1105      Cat.-No. 1105-01

**MIKRO 22 R**  
Benchtop centrifuge, refrigerated, without rotor  
Cat.-No. 1110      Cat.-No. 1110-01

* Power supply:	220 - 240 V 1~	110 - 127 V 1~	220 - 240 V 1~	110 - 127 V 1~
Frequency:	50 - 60 Hz	50 - 60 Hz	50 - 60 Hz	60 Hz
Consumption:	700 VA	650 VA	900 VA	900 VA
Radio interference:	EN 55011 ISM class B	FCC class A	EN 55011 ISM class B	FCC class A
Immunity:	EN 50082-2	—	EN 50082-2	—
Capacity:	60 x 1.5/2.0 ml (drum rotor), 48 x 1.5/2.0 ml (angle rotor)		60 x 1.5/2.0 ml (drum rotor), 6 x 50 ml (angle rotor)	
Speed/RCF:	n = 18,000 min <sup>-1</sup> / RCF 31,514			
Centrifuging chamber temperature:	—		controllable from -20°C to +40°C	
Running time:	1-99 min, ∞ (continuous run), key IMPULS (short cycle in seconds)			
Dimensions (HxWxD):	278 x 333 x 390 mm		278 x 333 x 620 mm	
Weight:	approx. 16 kg		approx. 36 kg	

\* other voltages on request

## Design

Housing and lid of metal for safety. Panelling finished in a scratch and impact resistant coating. Centrifuging chamber and inner lid of stainless steel. Lid locking, lid holding, and imbalance switch-off are standard.



**Andreas Hettich GmbH & Co. KG**  
Gartenstr. 100 · D-78532 Tuttlingen / Germany  
Phone +49(0)7461 705-0 · Fax +49(0) 7461 705-122

National Sales (07461) 705-200 · National Service (07461) 705-202  
Internat. Sales +49(0)7461 705-201 · Internat. Service +49(0)7461 705-203

**Hettich**  
ZENTRIFUGEN

www.hettichlab.com · info@hettichlab.com · service@hettichlab.com

1105.1103 sd/td © by Hettich, Tuttlingen · Printed in Germany · Design, form and colour modifications reserved.

DJB Labcare - The UK's Leading Centrifuge Specialist  
 info@djblabcare.co.uk www.djblabcare.co.uk 01908 612598